

Standard fastening material

T-headed bolt Hs 40w 22/80

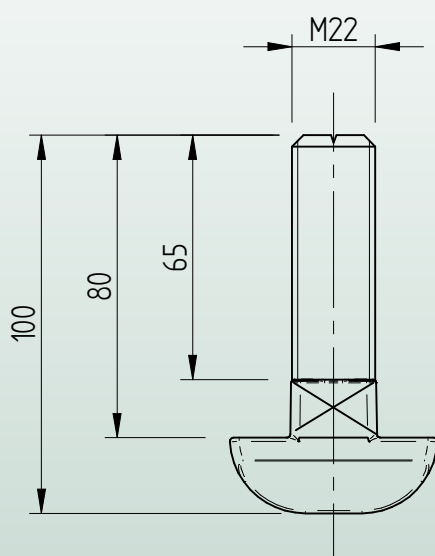
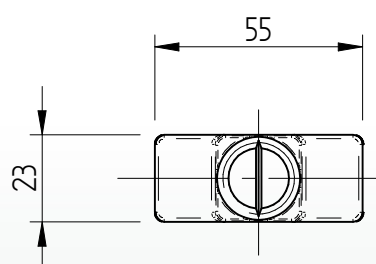
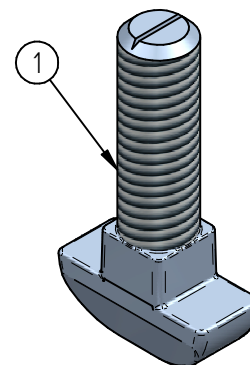

* Standard preservation is hot dip galvanized or self-coloured.
Other preservation and grade options in agreement.

1	Hammerhead bolt	S235JR Grade 4.6*	M22 x 80mm	Hs 40 w	m = 0,402 [kg]
Item	Description	Material	Type / Dimensions	Norm	Comments